

**TIGER** ELECTRONICS  
INC.

# POP-UP PALS PIANO™

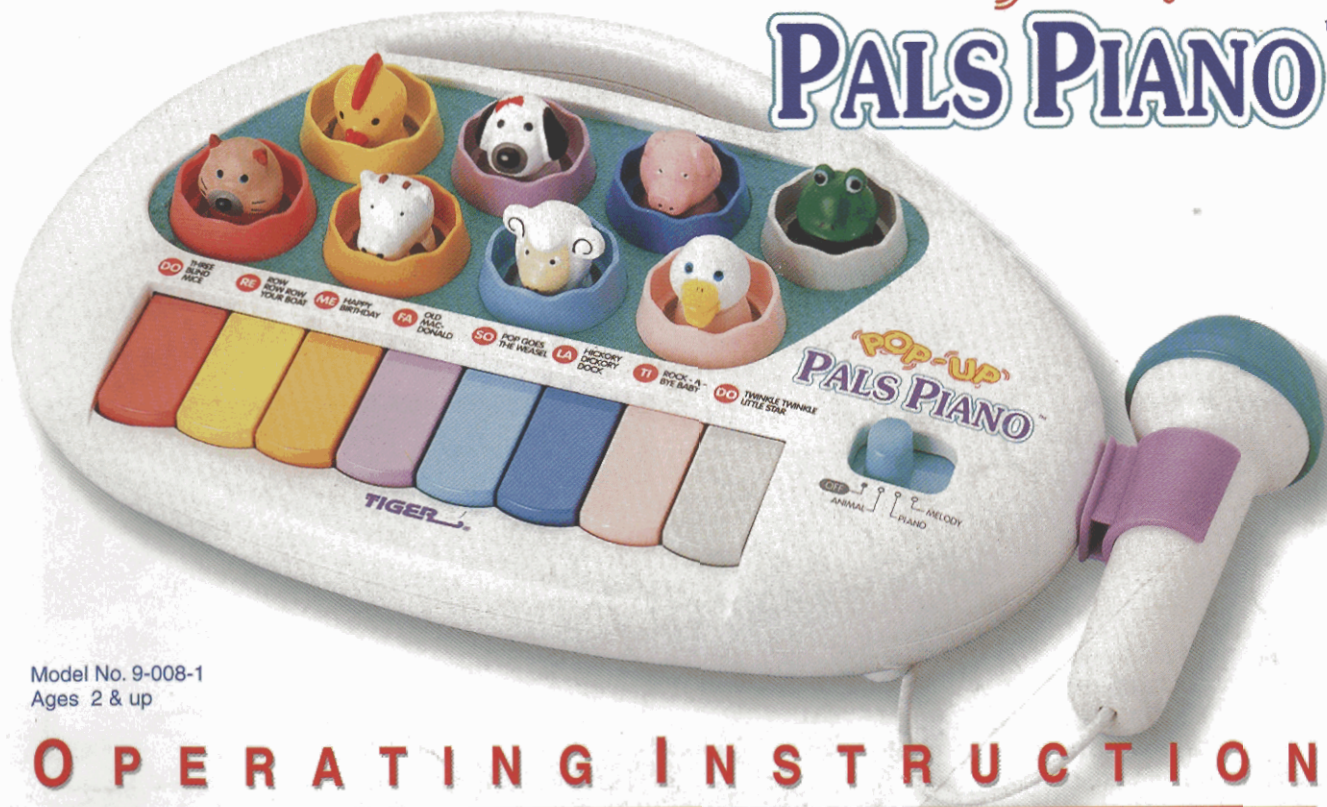

## INSERTING BATTERIES:

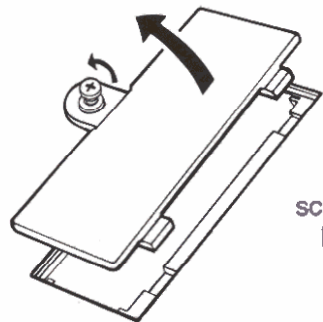

The Pop Up Pals Piano requires 4 "AA" or LR6 batteries that are to be installed at the bottom of the unit. Open the battery door by using a Philips® screwdriver, loosen screw in battery compartment door and pull back.

Insert 4 "AA" or LR6 batteries according to the diagram provided on the label in the compartment. (Battery installation should be done by adults.)

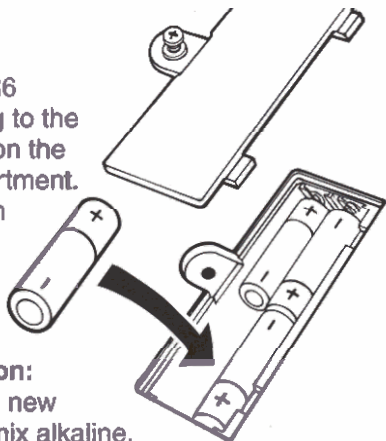

**For proper function:**  
Do not mix old and new batteries. Do not mix alkaline, standard (carbon - zinc) or rechargeable (nickel - cadmium) batteries.

## HOW TO USE

Each time a key is pressed on the POP UP PALS PIANO an animal POPS up. Each animal corresponds to a specific key. The keys and the rim around the animals are color coded so that kids will learn how to match colors as they watch their favorite animals pop up and down to the beat of the music.



## THREE MODES OF PLAY:

To turn ON the unit slide to one of the three different modes of play:

**ANIMAL** — The unit plays only animal sounds. Each time a key is pressed you will hear a specific animal sound.

**PIANO** — The unit plays only piano sounds. (Do, Re, Me, Fa, So, La, Ti, Do)

**MELODIES** — Press one of the keys once and it will play a melody that corresponds to the list of 8 built-in melodies on the unit. After the melody is finished, the animal will pop up and chime along.

Pop Up Pals Piano features an attached microphone that kids can speak into at anytime to sing along. There is a holder on the side of the unit provided to hold the microphone.

The Pop Up Pals Piano does not feature a volume dial. The volume of the toy is pre-set.

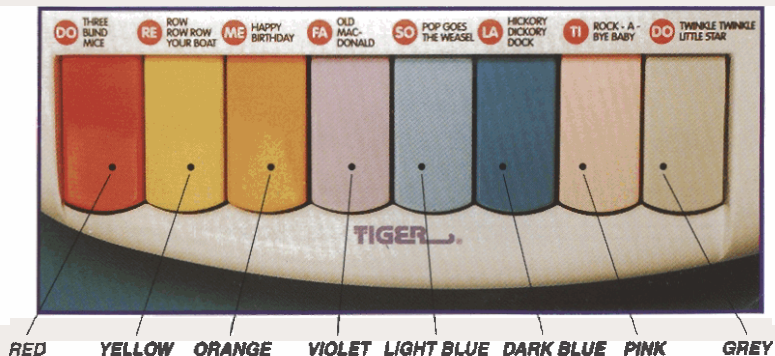

# Three Blind Mice



C G C G C

Three Blind Mice, Three Blind Mice.

Detailed description: This block shows the first line of the musical score. It consists of a single staff in treble clef with a key signature of one flat (B-flat). The melody is written in a simple, child-friendly style. Above the staff, colored circles indicate the notes: a red circle above the first note (C), a yellow circle above the second note (G), a red circle above the third note (C), a red circle above the fourth note (C), a yellow circle above the fifth note (G), and a red circle above the sixth note (C). The lyrics 'Three Blind Mice, Three Blind Mice.' are written below the staff.



G C G C

See how they run, See how they run! They

Detailed description: This block shows the second line of the musical score. It continues the melody from the first line. Above the staff, colored circles indicate the notes: a blue circle above the first note (G), a purple circle above the second note (G), a purple circle above the third note (C), a blue circle above the fourth note (G), a purple circle above the fifth note (C), a purple circle above the sixth note (G), a blue circle above the seventh note (C), and a blue circle above the eighth note (G). The lyrics 'See how they run, See how they run! They' are written below the staff.



G C G C G

all run af - ter the farm - er's wife; She cut off their tails with a

Detailed description: This block shows the third line of the musical score. It continues the melody. Above the staff, colored circles indicate the notes: a grey circle above the first note (G), a grey circle above the second note (G), a pink circle above the third note (C), a blue circle above the fourth note (G), a pink circle above the fifth note (C), a grey circle above the sixth note (G), a grey circle above the seventh note (C), a grey circle above the eighth note (G), a grey circle above the ninth note (C), a pink circle above the tenth note (G), a blue circle above the eleventh note (G), and a pink circle above the twelfth note (C). The lyrics 'all run af - ter the farm - er's wife; She cut off their tails with a' are written below the staff.

carv - ing knife, Did ev - er you see such a

sight in your life as Three Blind Mice.

# Rock-a-bye Baby

Rock - a - bye Ba - by, on the tree top,

When the wind blows, the crad - le will rock,

When the bough breaks, the crad - le will fall, And

down will come crad - le, ba - by and all.

The score consists of four staves of music in 3/4 time, key of B-flat major. Chords are indicated by colored circles above the notes: E<sup>b</sup> (orange), F<sup>m</sup> (purple), B<sup>b</sup> (blue), E<sup>b</sup> (orange), B<sup>b</sup>7 (grey), E<sup>b</sup> (grey), F<sup>m</sup> (grey), B<sup>b</sup>7 (grey), A<sup>b</sup> (grey), E<sup>b</sup> (pink), A<sup>b</sup> (blue), E<sup>b</sup> (blue), F<sup>m</sup> (purple), B<sup>b</sup>7 (orange), E<sup>b</sup> (yellow), and E<sup>b</sup> (orange).

# Happy Birthday

Happy Birthday to you, Happy Birthday to you, Happy

Birthday to you, Happy Birthday to you.

# Old MacDonald

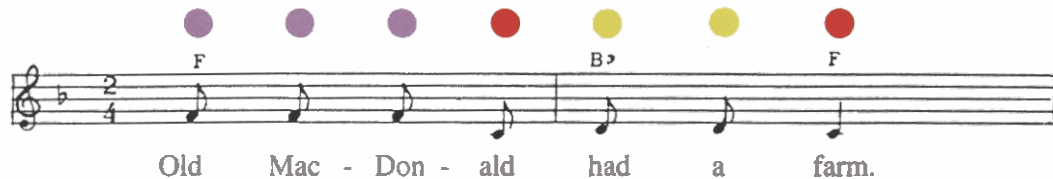

Musical staff for the first line of the song. The staff is in G major, 2/4 time, and contains the notes G4, A4, B4, C5, B4, A4, G4. Colored circles above the staff indicate chords: purple for F (F4), purple for F (F4), purple for F (F4), red for B♭ (B4), yellow for B♭ (B4), yellow for B♭ (B4), and red for F (F4).

Old Mac - Don - ald had a farm.

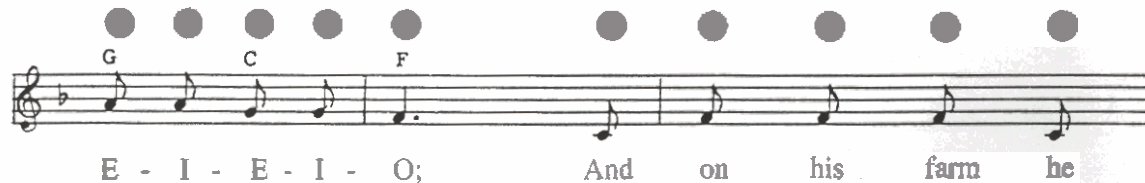

Musical staff for the second line of the song. The staff is in G major, 2/4 time, and contains the notes G4, A4, B4, C5, B4, A4, G4, F4, G4, A4, B4, C5, B4, A4, G4. Grey circles above the staff indicate chords: G (G4), C (C5), F (F4), and G (G4).

E - I - E - I - O; And on his farm he



Musical staff for the third line of the song. The staff is in G major, 2/4 time, and contains the notes G4, A4, B4, C5, B4, A4, G4, F4, G4, A4, B4, C5, B4, A4, G4. Colored circles above the staff indicate chords: yellow for B♭ (B4), yellow for F (F4), red for F (F4), blue for G7 (G4), blue for C7 (C5), purple for F (F4), red for F (F4), and red for F (F4).

had a cow, E - I - E - I - O; With a



moo - moo here and a moo - moo there,

here a moo, there a moo, ev - 'ry where a moo - moo,

Old Mac-Don-ald had a farm, E - I - E - I - O.

# Pop Goes the Weasel

D A7 D

All a - round the cob - bler's bench The

Detailed description: This musical staff is in the key of D major (one sharp) and 4/4 time. It contains the first line of the melody. Above the staff, there are seven black circles representing chords: D, A7, and D. The notes are: D4 (quarter), E4 (quarter), F#4 (quarter), G4 (quarter), A4 (quarter), B4 (quarter), and A4 (quarter).

A7 D A7

mon - key chased the wea - sel. The mon - key thought it was

Detailed description: This musical staff continues the melody. Above the staff, there are nine colored circles representing chords: purple, purple, blue, blue, blue, purple, red, purple, and blue. The notes are: G4 (quarter), A4 (quarter), B4 (quarter), A4 (quarter), G4 (quarter), F#4 (quarter), E4 (quarter), D4 (quarter), and C4 (quarter).

D G A D

all in fun. Pop! Goes The Wea -

Detailed description: This musical staff continues the melody. Above the staff, there are nine colored circles representing chords: blue, grey, blue, purple, grey, blue, purple, blue, and purple. The notes are: B4 (quarter), A4 (quarter), G4 (quarter), F#4 (quarter), E4 (quarter), D4 (quarter), C4 (quarter), B4 (quarter), and A4 (quarter).

# Hickory Dickory Dock

Hick - o - ry, Dick - o - ry, Dock! The

mouse ran up the clock; The clock struck one, and

down he run, Hick - o - ry, Dick - o - ry, Dock!

# Row, Row, Row Your Boat



Musical staff 1 with two measures. Above the staff are eight black dots. The first measure is labeled '1 C' and contains a quarter note C4, a quarter note C4, and a quarter note G4. The second measure is labeled '2 C' and contains a quarter note G4, a quarter note F4, a quarter note E4, a quarter note D4, and a half note C4. Below the staff is the lyrics: "Row, row, row your boat Gent - ly down the stream: \_\_\_".



Musical staff 2 with two measures. Above the staff are eight colored dots: three grey, three blue, and two red. The first measure is labeled '3 C' and contains a quarter note C4, a quarter note C4, a quarter note G4, a quarter note F4, a quarter note E4, and a quarter note D4. The second measure contains a quarter note D4, a quarter note C4, a quarter note G4, a quarter note F4, a quarter note E4, and a quarter note D4. Below the staff is the lyrics: "Mer - ri - ly, mer - ri - ly, mer - ri - ly, mer - ri - ly,".



Musical staff 3 with two measures. Above the staff are five colored dots: blue, purple, orange, yellow, and red. The first measure is labeled '4 C' and contains a quarter note C4, a quarter note C4, a quarter note G4, and a quarter note F4. The second measure contains a quarter note E4, a half note D4, and a half note C4. Below the staff is the lyrics: "Life is but a dream. \_\_\_".

# Twinkle, Twinkle, Little Star



D D G D A7 D A7 D

Twin-kle, twin-kle, lit - tle star, How I won - der what you are.



D A7 D A7 D A7 D A

Up a - bove the world so high, Like a dia - mond in the sky.



D D7 G B7 Em D A7 D

Twin - kle, twin - kle lit - tle star, How I won - der what you are!

## 90-DAY LIMITED WARRANTY

Tiger Electronics, Inc. (TEI) warrants to the original consumer purchaser of any of its electronic games or toys that the product will be free of defects in material or workmanship for 90 days from the date of original purchase.

During this 90-day warranty period, the product will either be repaired or replaced (at our option) without charge to the purchaser, when returned either to the dealer with proof of the date of purchase or to TEI when returned prepaid and insured with proof of date of purchase.

Product returned to TEI without original receipt or after the 90-day warranty has expired, but prior to one year from the original date of purchase, will be repaired or replaced (at our option) for a service charge of US\$10.00. Make check or money order payable to Tiger Electronics, Inc.

TEI will not be liable for loss of use of the product or other incidental or consequential costs, expenses, or damages incurred by the purchaser. Any implied warranties are limited in duration to the 90-day period from the original date of purchase.

All product returned must be shipped prepaid and insured for loss or damage to:

**Tiger Electronics, Inc. Repair Dept.**  
980 Woodlands Parkway  
Vernon Hills, Illinois 60061 U.S.A.

1. Pack the product carefully in the original box or use a good-quality carton with packing materials.
2. Include a letter with a complete description of the defect, a check if product is beyond the 90-day warranty, and your printed name, address and telephone number.

This warranty gives you specific legal rights and you may also have other rights which vary from state to state so the foregoing limitations may not apply to you. This warranty does not cover damages resulting from accident, unreasonable use, negligence, improper service or other causes not arising out of defects in material or workmanship.

**TIGER** ELECTRONICS  
INC.®

© 1995 COPYRIGHT & TM OF TIGER ELECTRONICS, INC.  
980 Woodlands Parkway, Vernon Hills, Illinois 60061, USA

© 1995 TIGER ELECTRONICS (UK) LLC.

Belvedere House, Victoria Avenue, Harrogate, North Yorkshire HG1 1EL, England

90081IWTIE-1  
PRINTED IN HONG KONG